

M8

8 X 8

6

6

6

6

1.5



STOR TASTEFSTAND

ALL-METAL / 100 BAR

ALL-METAL / 100 BAR

ALL-METAL / 100 BAR

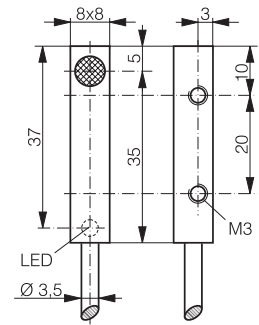
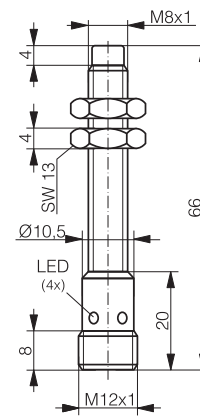
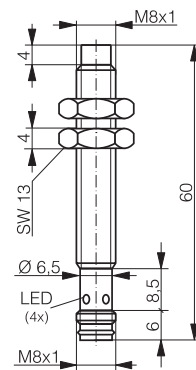
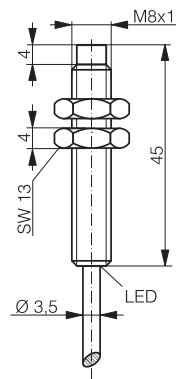
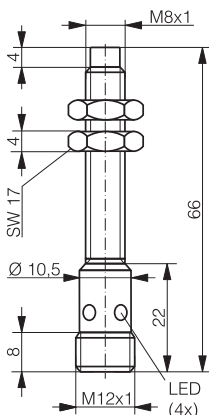

Forkrommet messing
M12 stik
IP 67
Uskærmet
500 Hz
Tabel 1
Diagram 2
Indbygget
10 ... 30 VDC
-25 ... +70 °C
≤ 200 mA
CE, UL, RoHS

Rustfrit stål V2A
PUR kabel type 3
IP 68
Uskærmet
700 Hz
Tabel 1
Diagram 1
Indbygget
10 ... 30 VDC
-25 ... +70 °C
≤ 200 mA
CE, UL, RoHS

Rustfrit stål V2A
M8 stik
IP 67
Uskærmet
700 Hz
Tabel 1
Diagram 1
Indbygget
10 ... 30 VDC
-25 ... +70 °C
≤ 200 mA
CE, UL, RoHS

Rustfrit stål V2A
M12 stik
IP 67
Uskærmet
700 Hz
Tabel 1
Diagram 2
Indbygget
10 ... 30 VDC
-25 ... +70 °C
≤ 200 mA
CE, UL, RoHS

Nickel-plated brass
PVC kabel type 2
IP 67
Skærmet
5,000 Hz
Tabel 1
Diagram 1
Indbygget
10 ... 30 VDC
-25 ... +70 °C
≤ 200 mA
CE, UL, RoHS

DW-AS-511-M8

DW-AS-512-M8

DW-AS-513-M8

DW-AS-514-M8

G, H, M, N (N.O.); M, N (N.C.)

DW-AD-711-M8

DW-AD-712-M8

DW-AD-713-M8

DW-AD-714-M8

DW-AS-711-M8-001

DW-AS-712-M8-001

DW-AS-713-M8-001

DW-AS-714-M8-001

A, B

DW-AS-711-M8

DW-AS-712-M8

DW-AS-713-M8

DW-AS-714-M8

G, H, M, N (N.O.); M, N (N.C.)

DW-AD-601-C8

DW-AD-602-C8

DW-AD-603-C8

DW-AD-604-C8

Induktive følere

Fotoceller

Optiske fibre

Ultralydsensorer

Kapacitive følere

Kabler & stikforb.

Tilbehør

Leksikon

Indeks

DIMENSION	∅ 8 X 8		
TASTEAFSTAND MM	1.5	2	2

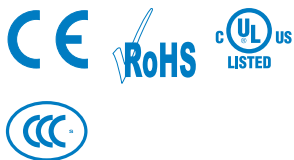

FORØGET TASTEAFSTAND

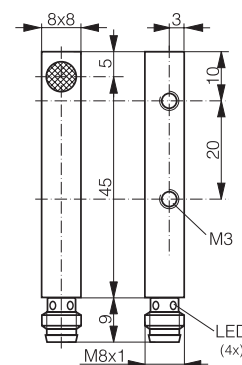
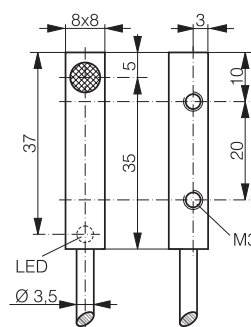
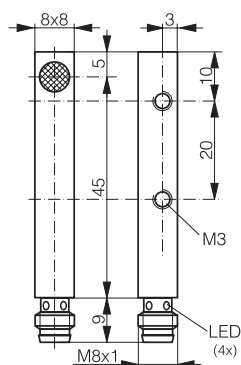

- 1) Standard kabellængde 2 m. ikke standard kabellængde og typer på bestilling. kabeltyper se side 271.
- 2) se side 132
- 3) se side 133
- 4) se side 268

TEKNISKE DATA

Materiale hus	Nickel-plated brass	Forkromet messing	Forkromet messing
Tilslutning ¹⁾	M8 stik	PVC kabel type 2	M8 stik
Tæthedsklasse	IP 67	IP 67	IP 67
Montage	Skærmet	Skærmet	Skærmet
Maks. tastefrekvens	5,000 Hz	3,000 Hz	3,000 Hz
Yderligere tekniske data ²⁾	Tabel 1	Tabel 1	Tabel 1
Tilslutning ³⁾	Diagram 1	Diagram 1	Diagram 1
LED	Indbygget	Indbygget	Indbygget
Forsyningsspænding	10 ... 30 VDC	10 ... 30 VDC	10 ... 30 VDC
Temperaturområde	-25 ... +70 °C	-25 ... +70 °C	-25 ... +70 °C
Udgangsstrøm	≤ 200 mA	≤ 200 mA	≤ 200 mA
Godkendelser	CE, UL, RoHS	CE, UL, RoHS	CE, UL, RoHS

TYPEBETEGNELSER: (FED: FORETRUNKNE TYPER)

NPN N.O.	DW-AS-601-C8-001	DW-AD-621-C8	DW-AS-621-C8-001
NPN N.C.	DW-AS-602-C8-001	DW-AD-622-C8	DW-AS-622-C8-001
PNP N.O.	DW-AS-603-C8-001	DW-AD-623-C8	DW-AS-623-C8-001
PNP N.C.	DW-AS-604-C8-001	DW-AD-624-C8	DW-AS-624-C8-001
Anvendelige stik ⁴⁾	A, B		A, B

8 X 8

M12

3

3

2

2

2



STOR TASTEAFSTAND

STOR TASTEAFSTAND

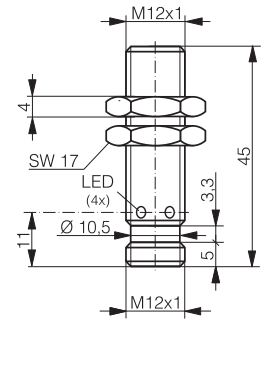
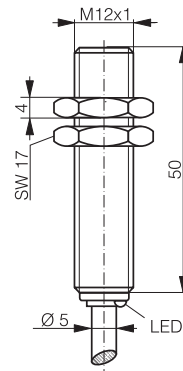
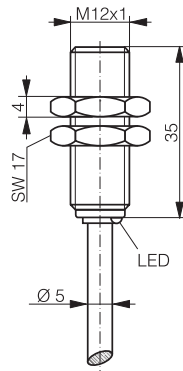
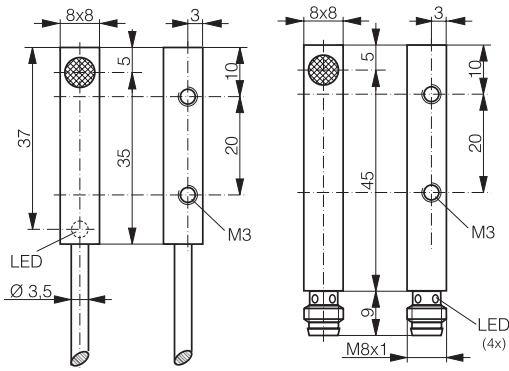

Forkromet messing	Forkromet messing	Forkromet messing	Forkromet messing	Forkromet messing
PVC kabel type 2	M8 stik	PVC kabel type 8	PVC kabel type 8	M12 stik
IP 67	IP 67	IP 67	IP 67	IP 67
Quasi-skærmet	Quasi-skærmet	Skærmet	Skærmet	Skærmet
1,000 Hz	1,000 Hz	3,000 Hz	3,000 Hz	3,000 Hz
Tabel 1	Tabel 1	Tabel 1	Tabel 1	Tabel 1
Diagram 1	Diagram 1	Diagram 1	Diagram 1	Diagram 2
Indbygget	Indbygget	Indbygget	Indbygget	Indbygget
10 ... 30 VDC	10 ... 30 VDC	10 ... 30 VDC	10 ... 30 VDC	10 ... 30 VDC
-25 ... +70 °C	-25 ... +70 °C	-25 ... +70 °C	-25 ... +70 °C	-25 ... +70 °C
≤ 200 mA	≤ 200 mA	≤ 200 mA	≤ 200 mA	≤ 200 mA
CE, UL, RoHS	CE, UL, RoHS	CE, CCC, UL, RoHS	CE, CCC, UL, RoHS	CE, CCC, UL, RoHS

DW-AD-501-C8	DW-AS-501-C8	DW-AD-601-M12-120	DW-AD-601-M12	DW-AS-601-M12-120
DW-AD-502-C8	DW-AS-502-C8	DW-AD-602-M12-120	DW-AD-602-M12	DW-AS-602-M12-120
DW-AD-503-C8	DW-AS-503-C8	DW-AD-603-M12-120	DW-AD-603-M12	DW-AS-603-M12-120
DW-AD-504-C8	DW-AS-504-C8	DW-AD-604-M12-120	DW-AD-604-M12	DW-AS-604-M12-120
	A, B			G, H, M, N (N.O.); M, N (N.C.)

Induktive følere

Fotoceller

Optiske fibre

Ultralydsensorer

Kapacitive følere

Kabler & stikforb.

Tilbehør

Leksikon

Indeks