

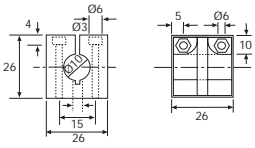









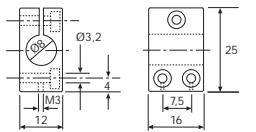

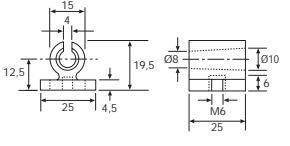

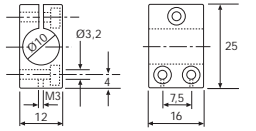

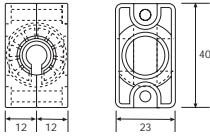

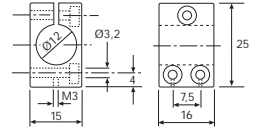

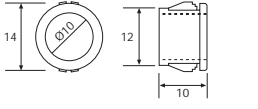

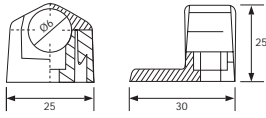

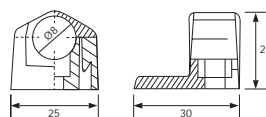

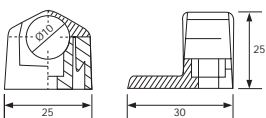

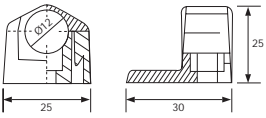

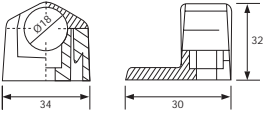

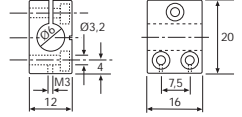

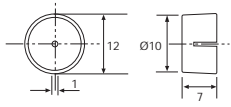

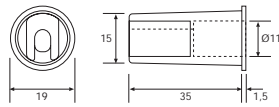

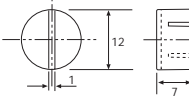

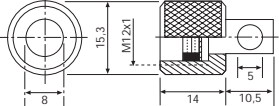
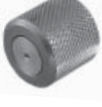
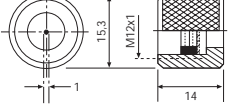

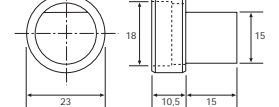

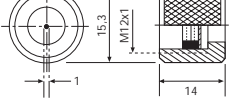

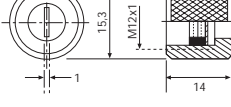

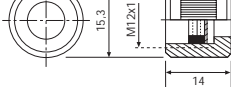
# MONTERINGSBESLAG

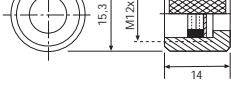
<p>TR 10S Monteringsbeslag. Størrelse: Ø 10. Materiale: Polykarbonat.</p>			<p>TR 8M Monteringsbeslag. Størrelse: Ø 8. Materiale: Messing.</p>		
<p>TR 10KB Monteringsclips. Størrelse: Ø 10. Materiale: Polykarbonat.</p>			<p>TR 10M Monteringsbeslag. Størrelse: Ø 10. Materiale: Messing.</p>		
<p>TR 10KG Monteringsbeslag (drejbar). Størrelse: Ø 10. Materiale: Polykarbonat.</p>			<p>TR 12M Monteringsbeslag. Størrelse: Ø 12. Materiale: Messing.</p>		
<p>TR 10SB Snap-beslag. Størrelse: Ø 10. Materiale: Polykarbonat.</p>			(Enheder i mm)		
<p>TRN 6 Monteringsbeslag (klik). Størrelse: Ø 6. Materiale: Polykarbonat.</p>					
<p>TRN 8 Monteringsbeslag (klik). Størrelse: Ø 8. Materiale: Polykarbonat.</p>					
<p>TRN 10 Monteringsbeslag (klik). Størrelse: Ø 10. Materiale: Polykarbonat.</p>					
<p>TRN 12 Monteringsbeslag (klik). Størrelse: Ø 12. Materiale: Polykarbonat.</p>					
<p>TRN 18 Monteringsbeslag (klik). Størrelse: Ø 18. Materiale: Polykarbonat.</p>					
<p>TR 6M Monteringsbeslag. Størrelse: Ø 6. Materiale: Messing.</p>					

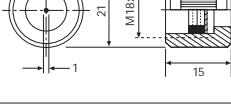
<p>TRE Blænde med 1 mm hul. Størrelse: Ø 10. Materiale: Aluminium.</p>			<p>TU 12 Blænde (tubus). Størrelse: Ø 10. Materiale: Polykarbonat.</p>		
<p>TRD Blænde med 1 mm slidse. Størrelse: Ø 10. Materiale: Aluminium.</p>			<p>TRWM 90 90° vinkeladapter. Størrelse: M12. Materiale: Rustfrit stål.</p>		
<p>TREM 12 Blænde med 1 mm hul. Størrelse: M12. Materiale: Rustfrit stål.</p>			<p>FA 18 SO 90° angle adapter. Størrelse: M18. Materiale: Polykarbonat.</p>		
(Enheder i mm)					
<p>TREGM 12 Blænde med 1 mm hul med beskyttelses- glaskappe. Størrelse: M12. Materiale: Rustfrit stål</p>					
<p>TRDGM 12 Blænde med 1 mm slidse med beskyttelses- glaskappe. Størrelse: M12. Materiale: Rustfrit stål</p>					
<p>TRGM 12 Beskyttelses-glaskappe. Størrelse: M12. Materiale: Rustfrit stål.</p>					
<p>TRLM 12 Linse. Størrelse: M12. Materiale: Rustfrit stål.</p>					
<p>TREGM 18 Blænde med 1 mm hul med beskyttelses- glaskappe. Størrelse: M18. Materiale: Rustfrit stål</p>					
<p>TRGM 18 Beskyttelses-glaskappe. Størrelse: M18. Materiale: Rustfrit stål.</p>					
<p>TRPG 11 Blænde (tubus). Størrelse: Ø 10. Materiale: Rustfrit stål.</p>					

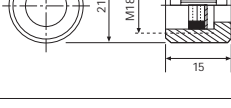
## REFLEKTORER

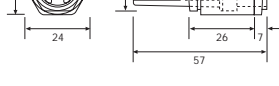
ILR 1  
Rektangulær reflektor.  
Størrelse: 55 mm x 80 mm.

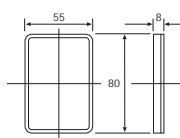
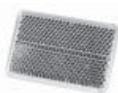



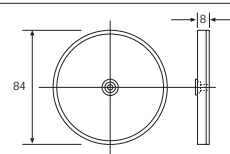

ILR 3  
Cirkulær reflektor.  
Størrelse: Ø 84.

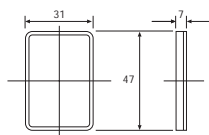
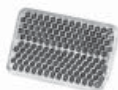

ILR 2  
Rektangulær reflektor.  
Størrelse: 47 mm x 31 mm.

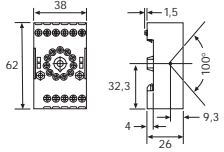

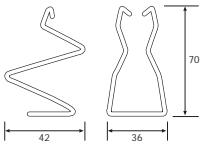
(Enheder i mm)

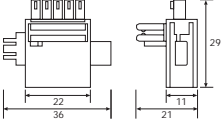
<p>TR 11 Stiksokkel for PA fotocelleforstærkere og PP Power Pack.</p>			<p>HFS Fjederholder for TR 11 stiksokkel.</p>		
<p>(Enheder i mm)</p>					
<p>Bus Connector 22.5 Busforbindelse for PAB fotocelleforstærkere og PPB Power Pack.</p>					

# KABLER

## Beskrivelse

- ☒ Kabler for fotoceller
- ☒ M8 eller M12 stik
- ☒ Lige eller vinkelstik
- ☒ PUR eller PVC



## Kabler

Type/Design	Omløbermøtrik	Tæthedsklasse	Materiale	Længde	Stik				
					3-polet, M8	4-polet, M8	4-polet, M12		
					Bestillingsnummer				
Lige		Nej	PVC	5m	ELKA K 3308 PVC5M S	ELKA K 4408 PVC5M S	—		
		Ja			ELKA KV 3308 PVC5M S	ELKA KV 4408 PVC5M S	ELKA KV 4412 PVC5M S		
Vinkel		Nej			ELWIKA K 3308 PVC5M R	ELWIKA K 4408 PVC5M R	—		
		Ja			ELWIKA KV 3308 PVC5M R	ELWIKA KV 4408 PVC5M R	ELWIKA KV 4412 PVC5M R		
Lige		Nej			PUR	5m	ELKA K 3308 PUR5M S	ELKA K 4408 PUR5M S	—
		Ja					ELKA KV 3308 PUR5M S	ELKA KV 4408 PUR5M S	ELKA KV 4412 PUR5M S
Vinkel		Nej					ELWIKA K 3308 PUR5M R	ELWIKA K 4408 PUR5M R	—
		Ja					ELWIKA KV 3308 PUR5M R	ELWIKA KV 4408 PUR5M R	ELWIKA KV 4412 PUR5M R

## Tilslutningsdiagrammer

